



HUACHUAN

華川壓鑄

HUACHUAN DIE CASTING & MACHINING

都江堰華川壓鑄有限公司

DUJIANGYAN HUACHUAN DIE CASTING & MACHINING Co., LTD

關於華川壓鑄

ABOUT HUACHUAN

關於華川壓鑄



都江堰華川壓鑄有限公司（ISO 9001:205）成立於2003年，占地6000平米擁有4000平米生產設施車間，位於四川成都市，是西南地區集鋁合金、鋅合金零配件壓鑄製造和機械加工、表面處理於一體的綜合性專業壓鑄企業。

公司致力於設計和製造用於汽車及新能源汽車、摩托車、家電電器、LED照明外殼、通訊設備、電子脈沖閥和眾多機械應用的鋁合金壓鑄零件。公司擁有不同噸位的壓鑄機，數控加工中心，數控車床，多種表面處理設備等各類加工設備，壓鑄年產能達到2000噸。

公司以客戶需求為嚮導，以高新技術為基礎，以優秀質量為保證，以可靠信譽為保障，以“誠信，質量，實干、服務”為宗旨，以合理價格按時供應優質產品服務為目標，歡迎海內外客戶考察合作！



Huachuan Die Casting focuses on one-stop service for die casting products in various industries

Dujiangyan Huachuan Die Casting Co., Ltd. (ISO 9001: 205) was established in 2003. It covers an area of 6,000 square meters and has a production area of 4,000 square meters. It is located in Chengdu, Sichuan. Combining die-casting manufacturing, machining and surface treatment of aluminum alloy comprehensive integrated professional die-casting enterprise in southwest of China.

The company is committed to designing and manufacturing aluminum alloy die-casting parts for automobiles and new energy vehicles, motorcycles, home appliances, LED photo housings, communication equipment, electronic pulse valves and many mechanical applications. The company has various tonnage die-casting machines, CNC machining centers, CNC lathes, various surface treatment equipment and other various processing equipment.

The annual production capacity of die casting reaches 2,000 tons.

The company is guided by customer needs, based on high and new technology, guaranteed by excellent quality, guaranteed by reliable reputation, with the tenet of "integrity, quality, hard work and service", and the goal of supplying high-quality products and services at reasonable prices and on time. Welcome Clients at home and abroad visit and cooperate!

組織架構 ORGANIZATION

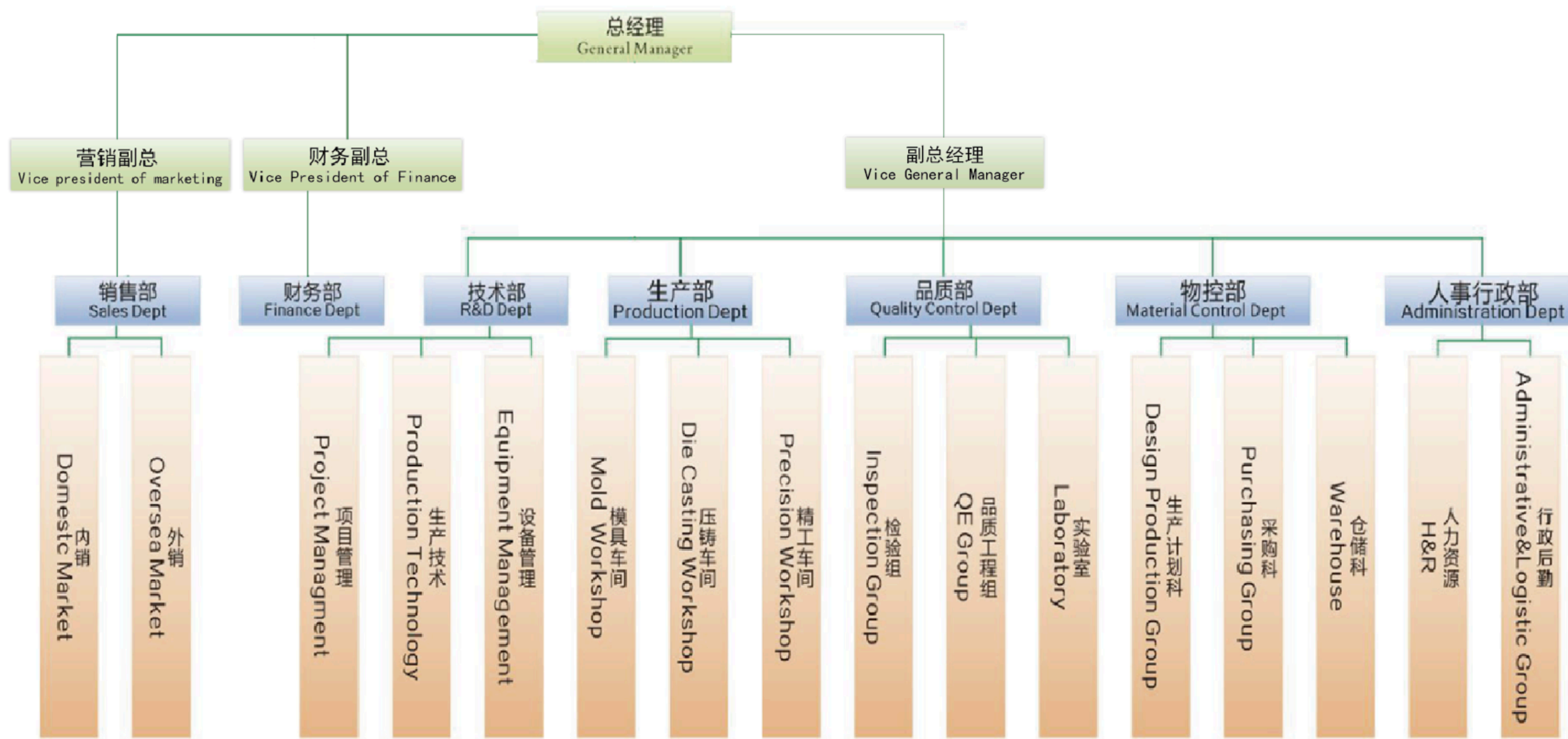

公司名称 Company	都江堰华川压铸有限公司 Dujiangyan Huachuan Die Casting & Machining Co., Ltd
所有权 Ownership	Sole proprietorship 独资
成立 Found & Location	2003年 四川省 成都 Founded in Year 2003 in Chengdu, Sichuan, China
销售额 Turnover	2019年 3600万人民币 36M CNY in year 2019
销售额 Turnover	占地6000平米 厂房4000平米 Land occupation 6000m ² Workshop 4000 m ²
质量体系 Quality System	ISO 9001:2015
主营产品 Main Product	Machined casting parts (Aluminum & Ma & Zinc) 铝 / 镁 / 锌 合金压铸加工件
员工 Staff	160人
业务范围 Business	汽车及新能源汽车、摩托车、家电电器、数码产品、LED照明外壳、通讯设备、电子脉冲阀和众多工业机械应用的合金压铸零件 Automotive and new energy vehicles、Electrical appliances、digital product、LED lighting housing、Communication equipment

經營理念 Business philosophy

客戶至上 質量第一 誠信為本 追求卓越
Customer First Quality First Honesty The pursuit of excellence

核心價值觀 Core Value

自律刻苦 關注細節 持續改進 持之以恆
Self-discipline Attention to detail Keep improve Perseverance

下一道工序是客戶
The next process is the customer

十四字方針 Guidelines

抓緊每一道工序 做好每一件產品
Seize every process Make every product

質量控制

华川压铸公司通过ISO 9001:2015质量管理体系认证，计划于2021年完成TS16949认证，产品品质在同行业中名列前茅。

正規規模

为实现华川压铸长远发展，公司投资修建正规现代化厂房双证齐全，更新压铸设备、精密机加加工设备，聘用全国优质管理团队，配合国家环保发展实现绿色生产，通过环评审批。

價優

华川压铸本着诚信经营的理念，在保证质量的前提下，不忘初心，全心全意为客户服务，运用自身的资源优势，为客户提供双方共赢的适宜价格。

優質服務

无论是售前或是售后，华川压铸都以最诚挚的态度，竭诚为客户提供周到的服务，保证从业务了解、接洽、维护等等，在最快速的时间中作出响应。

Quality Control

Huachuan Die Casting Company passed ISO 9001: 2015 quality management system certification. Plan to complete TS16949 certification in 2021. In the same supply system, the products produced by Huachuan Die Casting are among the best in the industry and the quality is reliable.

Scale

In order to achieve the long-term development of Huachuan Die Casting, the company invested in the construction of a formal modern plant, purchased die casting equipment, precision machining equipment, hired a national high-quality management team, cooperated with the national environmental protection development to achieve green production, and passed the environmental review and approval.

High quality and good price

Huachuan Die-casting adheres to the concept of honesty management, and on the premise of ensuring quality, it does not forget its original intention, serves customers wholeheartedly, and uses its own resource advantages to provide customers with suitable prices for both parties.

Service

No matter before or after sale, Huachuan Die-casting is dedicated to provide customers with thoughtful service with the most sincere attitude, ensuring that business understanding, contact, maintenance, and so on, will respond in the fastest time.

經營狀況

BUSINESS REPORT

華川歷年
產值表

Annual output
value table

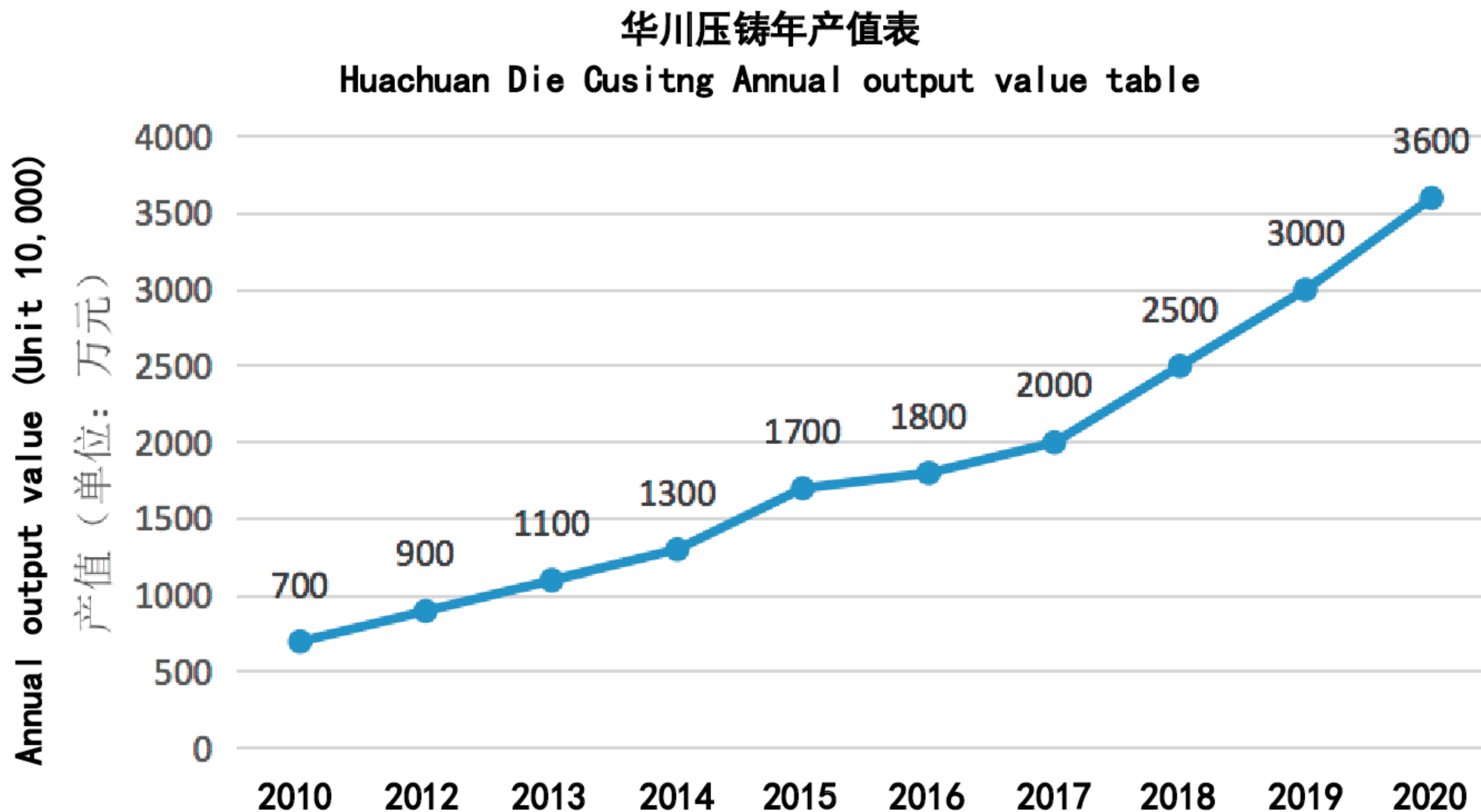

主要客户 MAJOR CLIENT



公司产品主要直接客户和间接客户

The company's products are mainly direct and indirect customers

企業環境

FACTORY

廠房環境 WORKSHOP



廠房環境 WORKSHOP



廠房環境 WORKSHOP



廠房環境 WORKSHOP



廠房環境 WORKSHOP





廠房環境 WORKSHOP



压铸满负荷产能 Die Casting Produce Capacity

8,700,000件/年 8,700,000pcs/year

工序名称 / Process	吨位 / Tonnage	品牌 / Brand	数量 / Total Machine	月满产量 / Total Capacity Per Month
压铸 Die-Casting	280	同向 TX	1	128000
	350	尚富 Shangfu	1	240000
	400	伊之密 Yizumi	1	240000
	450	穆勒 Muller	1	240000



机械加工设备 Machining Equipment

设备名称 Equipment name	设备型号 Equipment Spec.	设备品牌 Brand Contry/Region	机器数量 Qty	轴 Axis	工作天数/月 days/month working	设备维护天数 maintenance equipment (day)	停止/切换 Stop / Swithcing machine	实际生产工作日 eact mass workng days	工作时间/天(小时) Working time/day (hours)	功效分钟 efficacy minutes
CNC加工中心 CNC Milling Center	JTV850C	济南三机 China Jinan	4	3	28	2	3	25	20	25000
CNC加工中心 CNC Milling Center	VMC1000B	沈阳机床 China	2	3	28	2	3	25	20	25000
数控车床 CNC lathe	CJK6150	浙江兆山机床 China	2	2	28	2	3	25	20	23760
数控车床 CNC lathe	CJK6140	浙江兆山机床 China	1	2	28	2	3	25	20	24000
数控车床 CNC lathe	LK32	浙江联济机床 China	2	2	28	2	3	25	20	25400
数控车床 CNC lathe	CJK6140	浙江兆山机床 China	4	2	28	2	3	25	20	24000
普车 lathe	CK6140	沈阳机床 China	1	2	28	2	3	25	20	20000
普车 lathe	CK6136	沈阳机床 China	1	2	28	2	3	25	20	18900
多头钻 Multi-head drill		杭州西湖 China	4	1	28	2	3	25	20	
多头钻 Multi-head drill		自贡德沃 China	2	1	28	2	3	25	20	
台钻 Bench drill		杭州西湖 China	3	1	28	2	3	25	20	
攻丝机 Tapping machine		自贡德沃 China	2	1	28	2	3	25	20	
铣床 Milling machine	X5325G	南通 China	1	1	28	2	3	25	20	
拉床 Broaching			1	1	28	2	3	25	20	

品質管理

PRODUCT QUALITY CONTROL



华川压铸公司现阶段通过的是ISO 9001:2015质量管理体系认证

Huachuan Die Casting Co., Ltd. has passed the ISO 9001: 2015 quality management system certification at this stage.

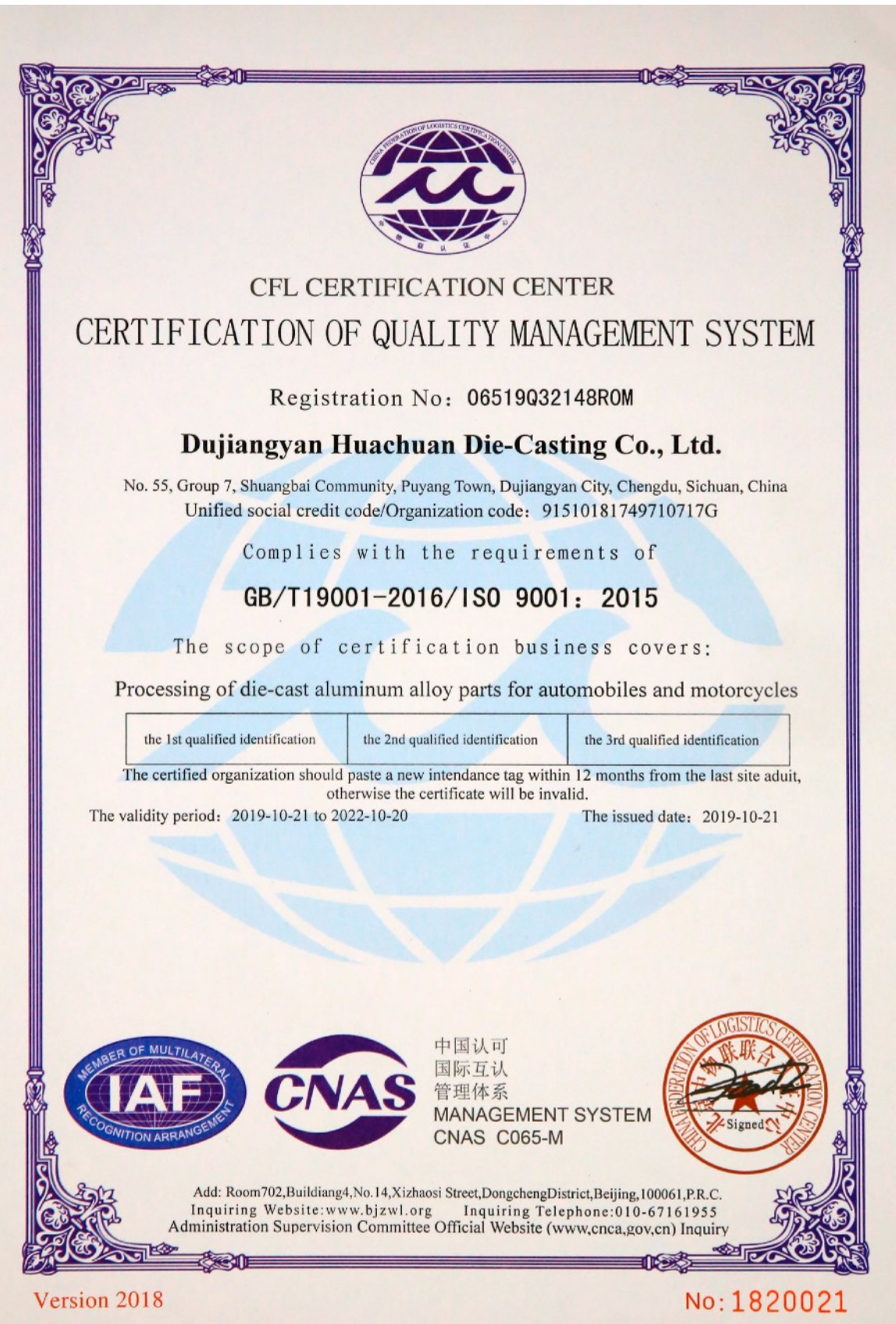
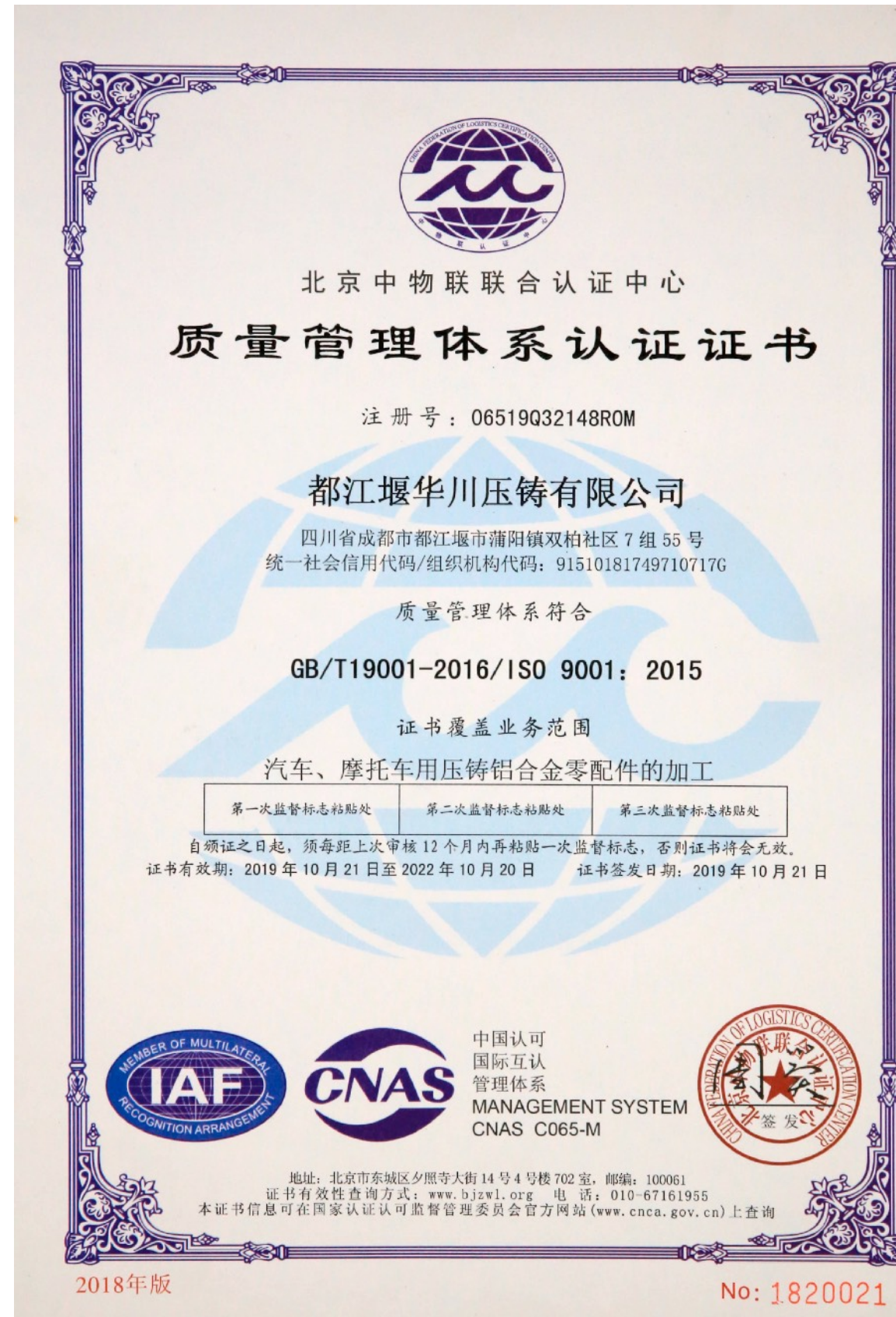

產品圖冊

PRODUCT BOOK

產品圖冊 PRODUCT

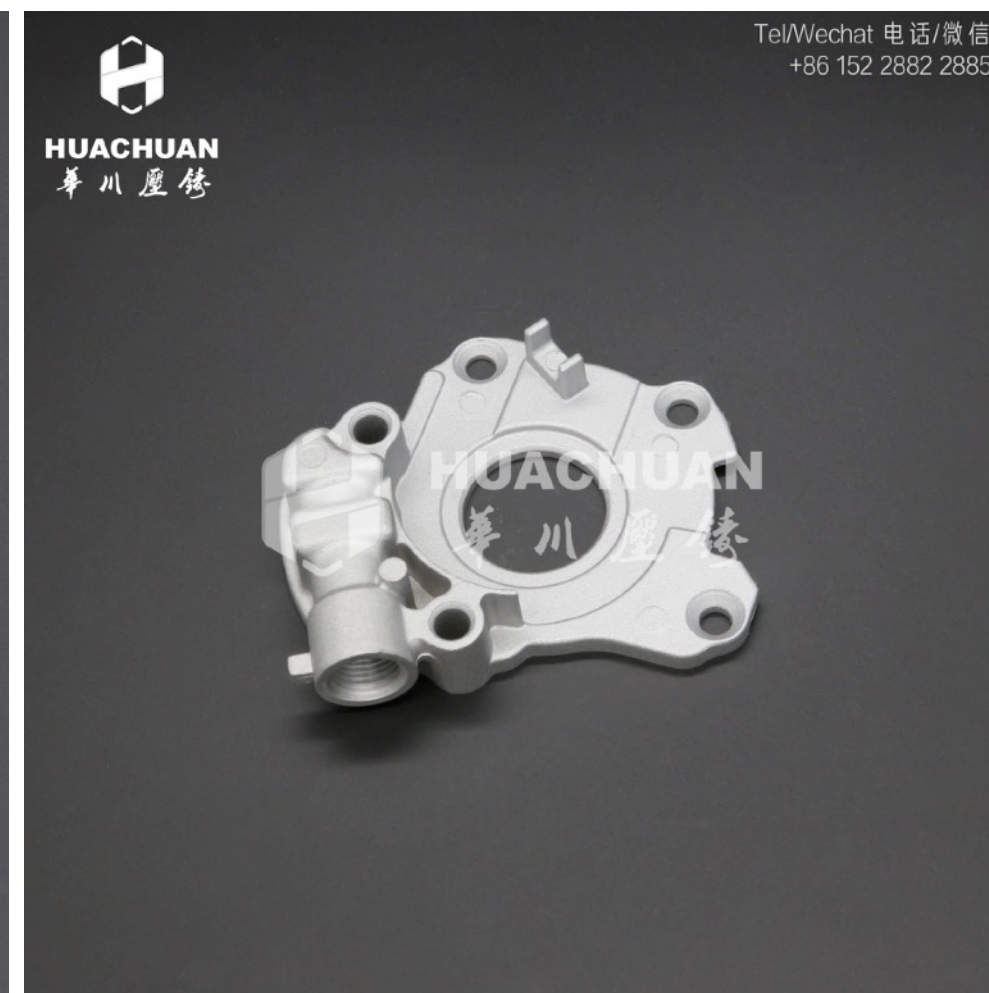

產品圖冊 PRODUCT

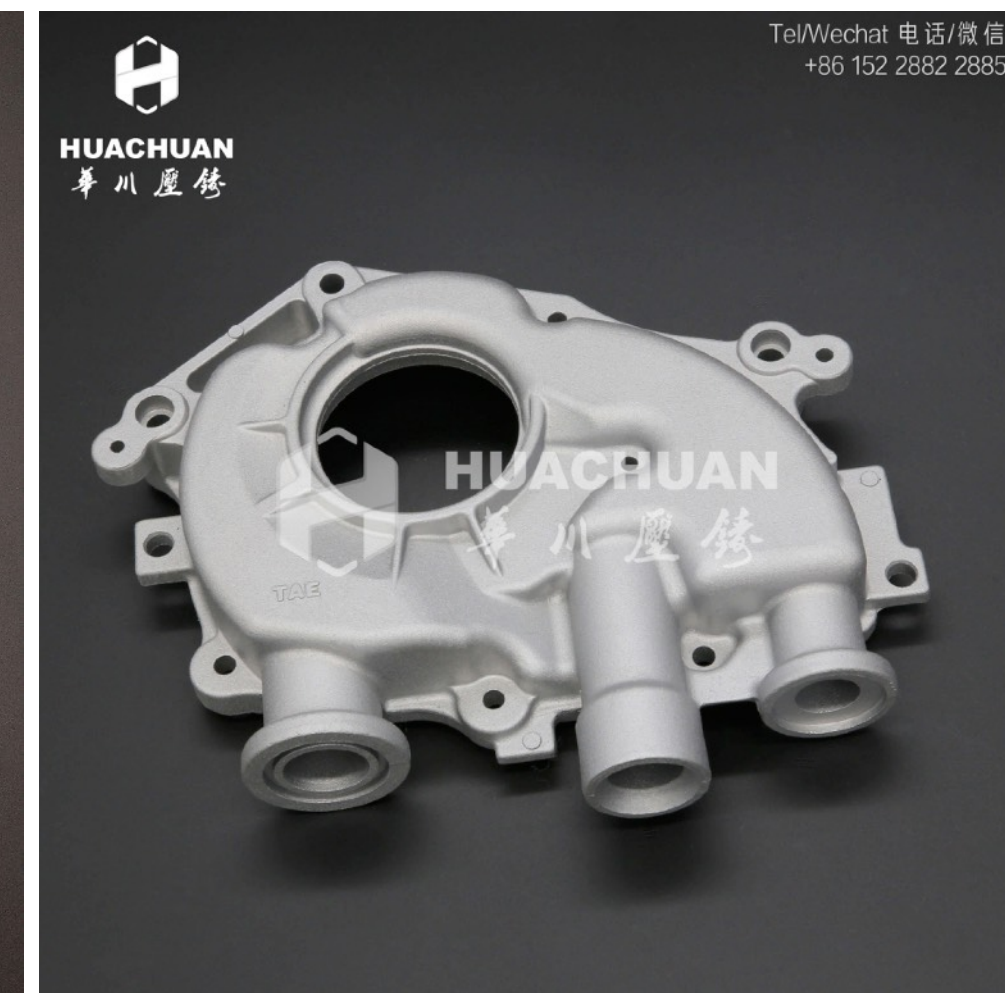
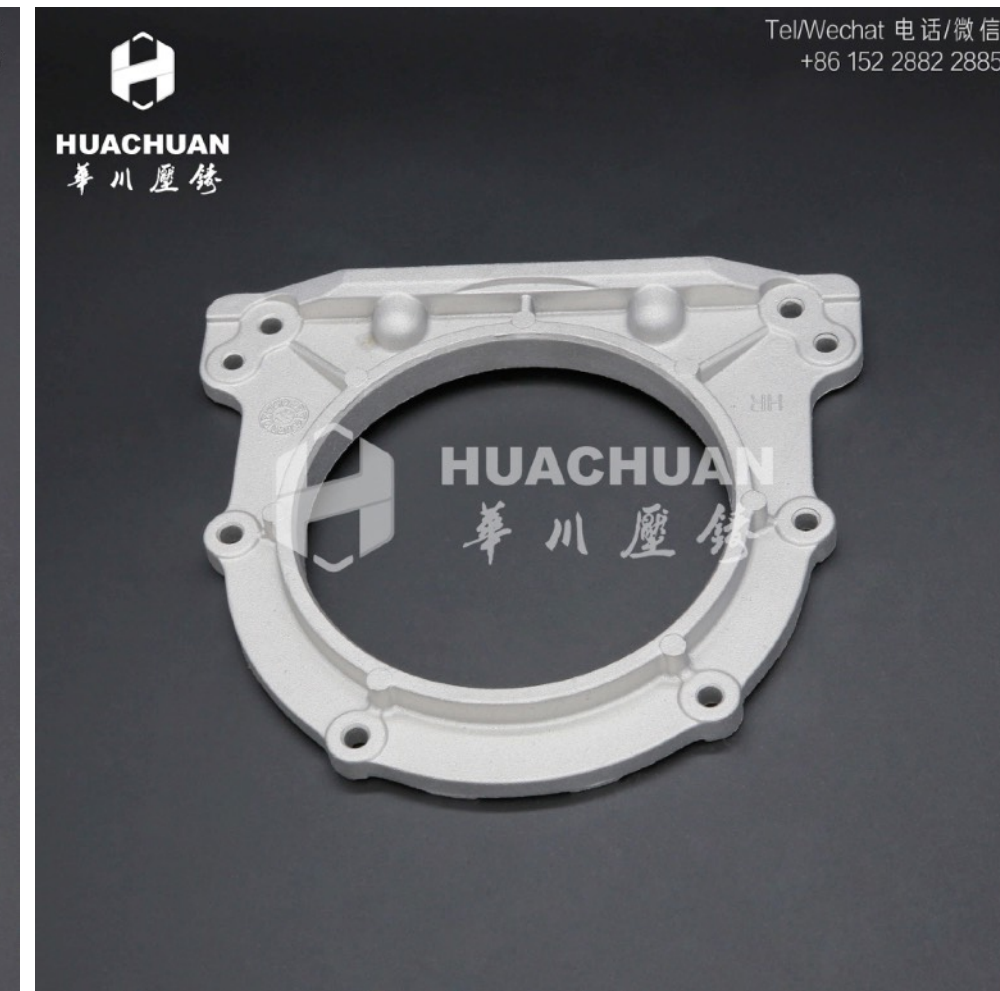
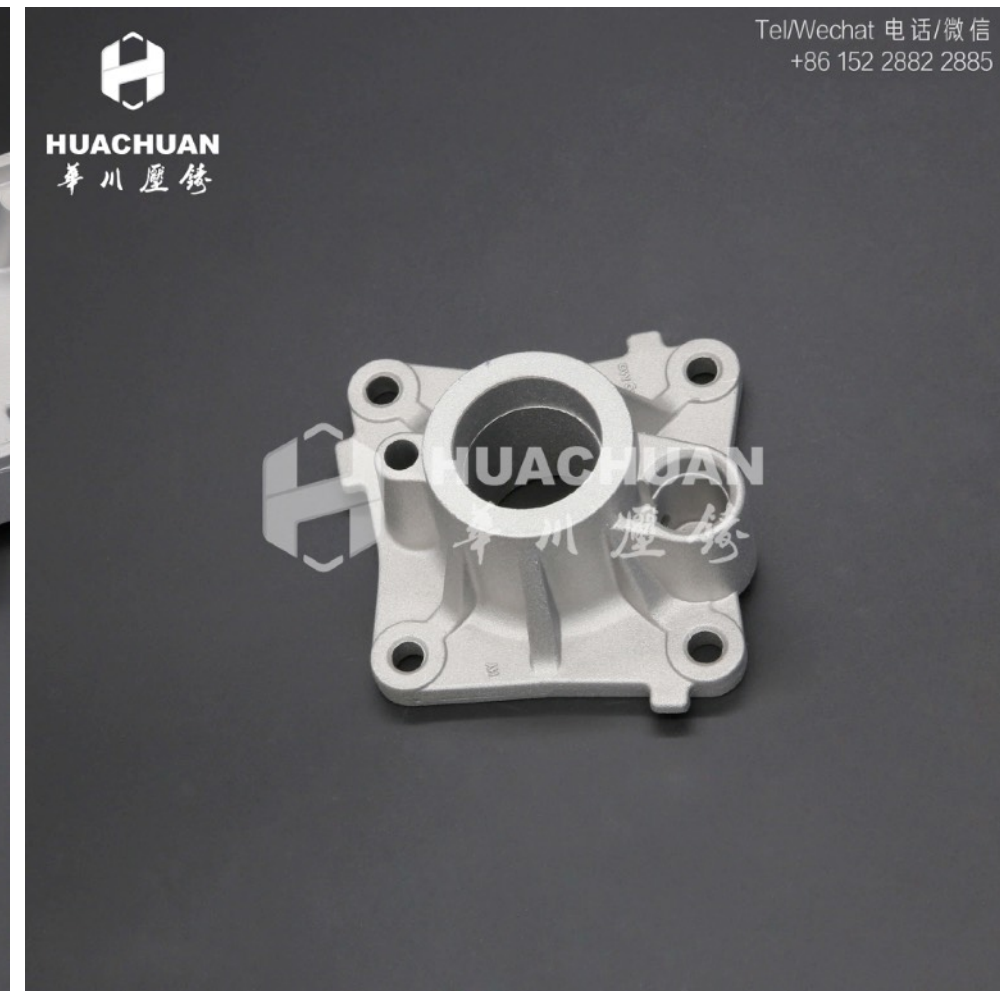

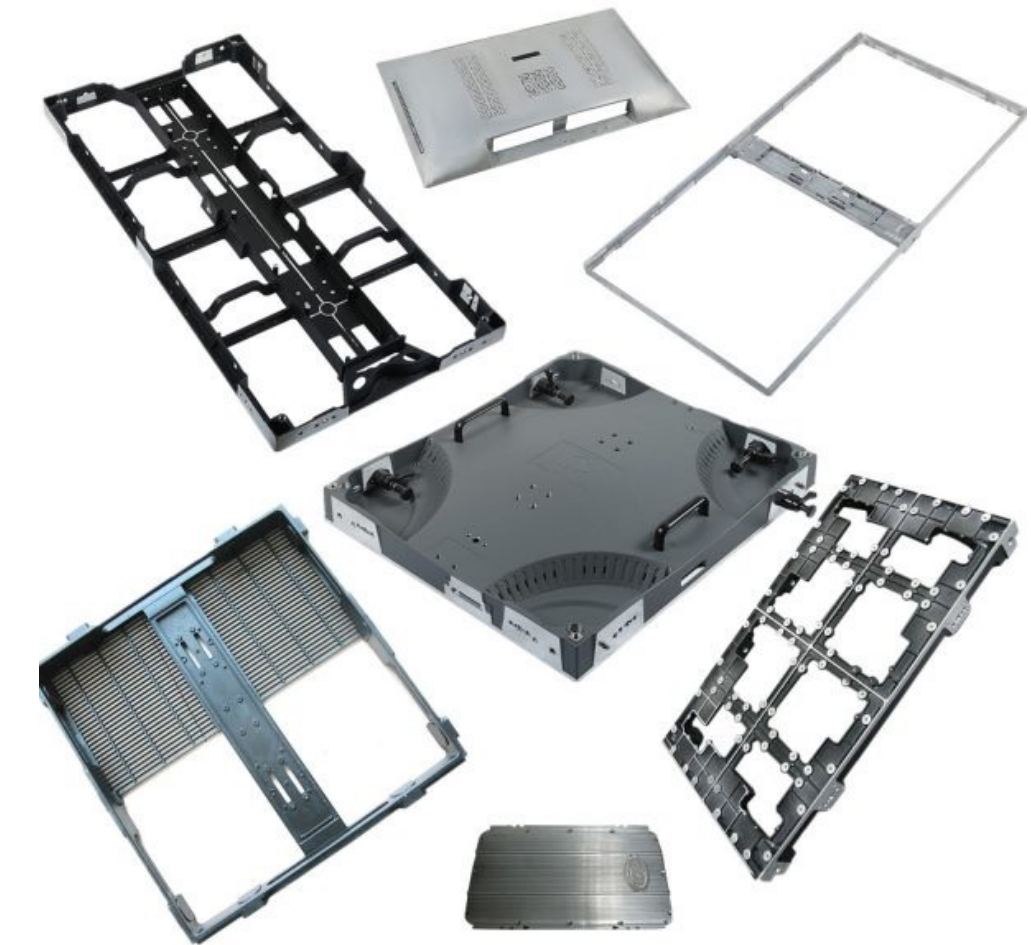
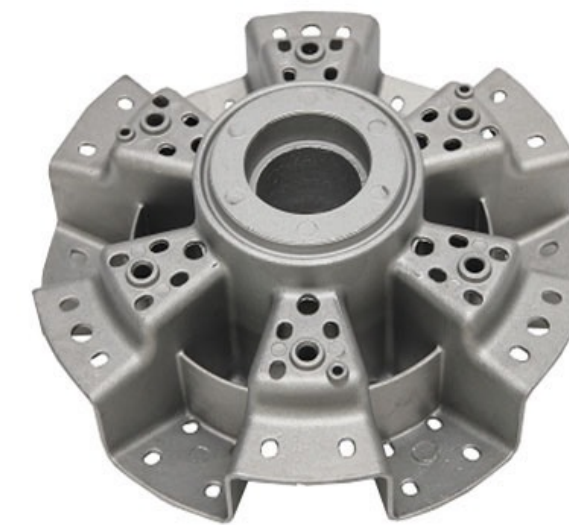
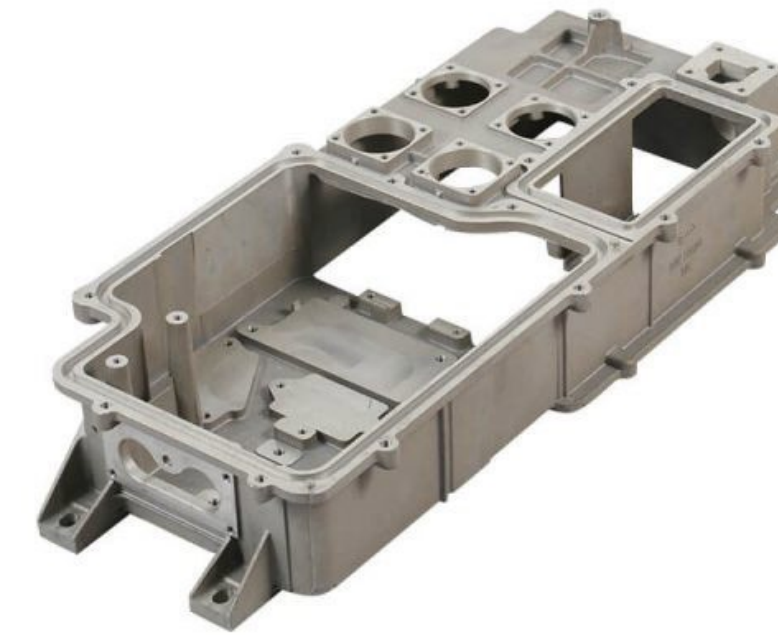

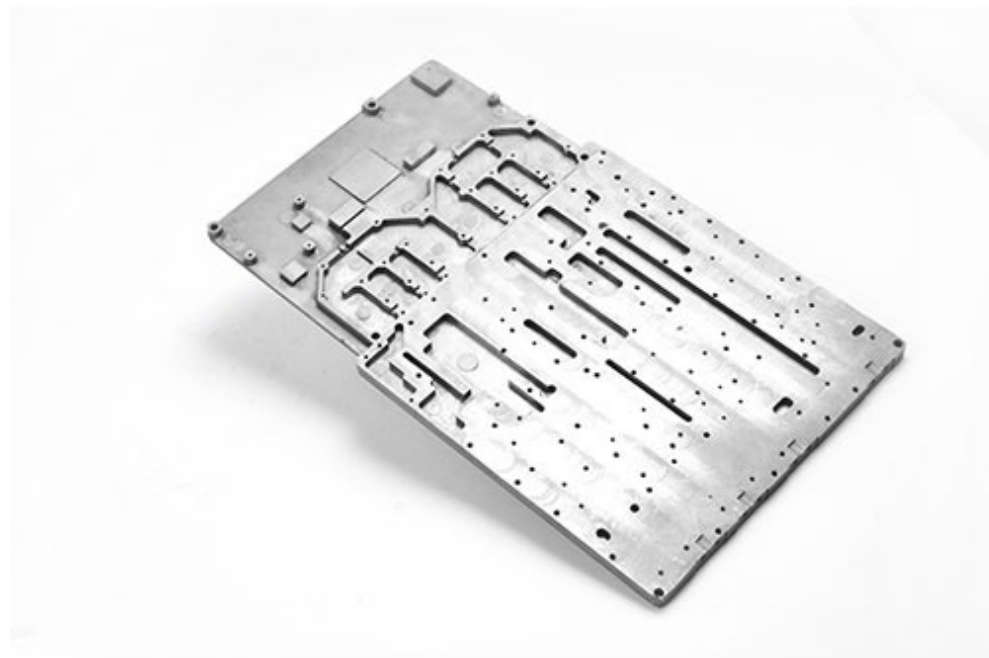
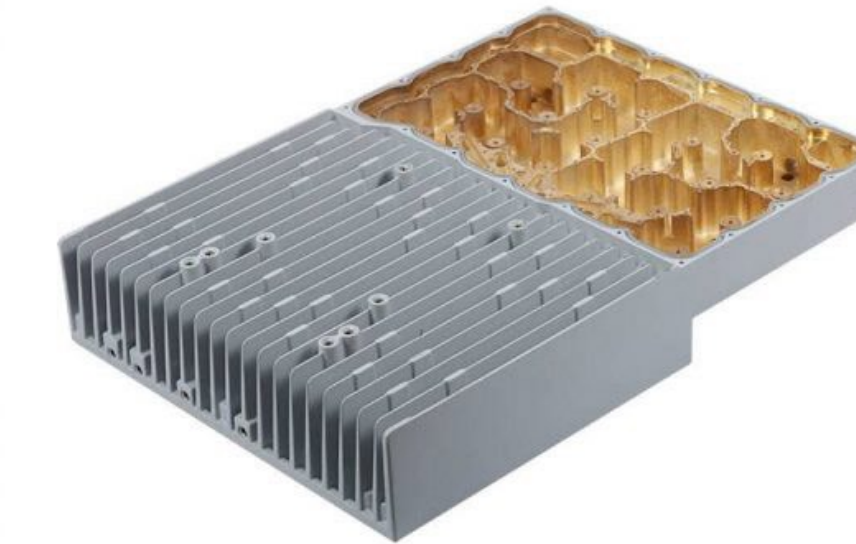
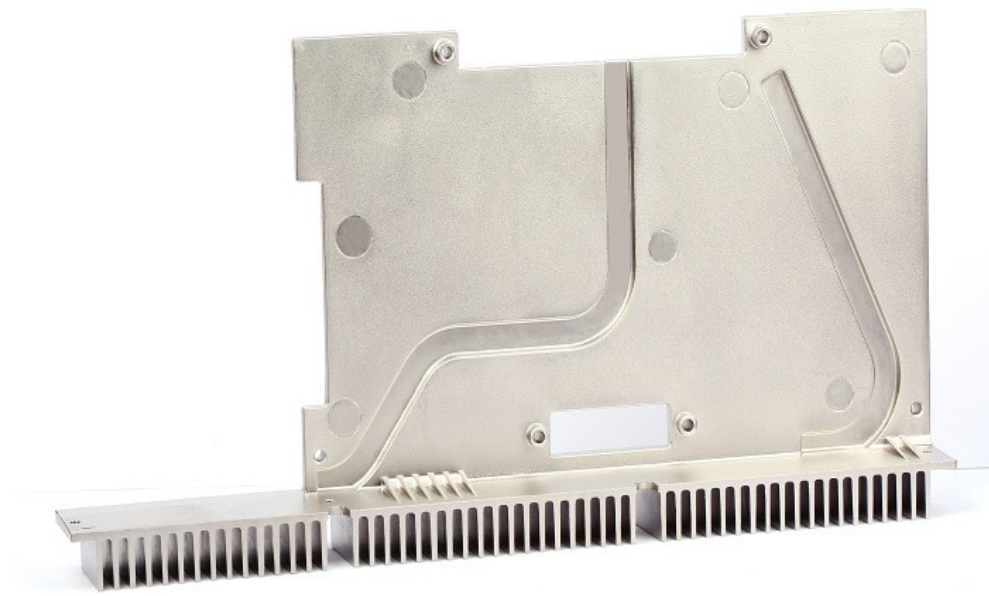

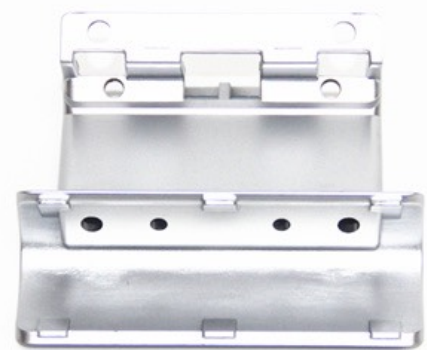

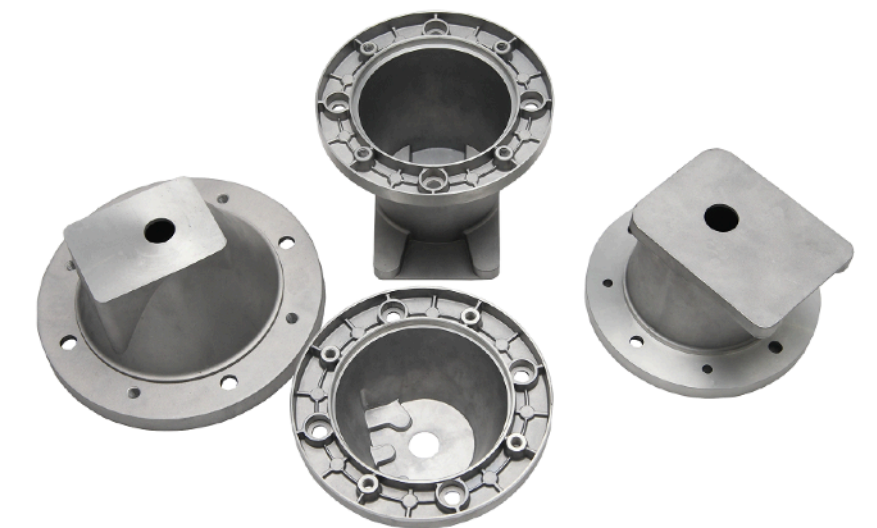
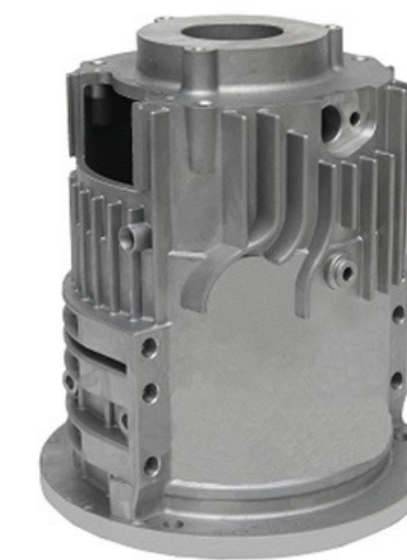

榮譽
HONOR

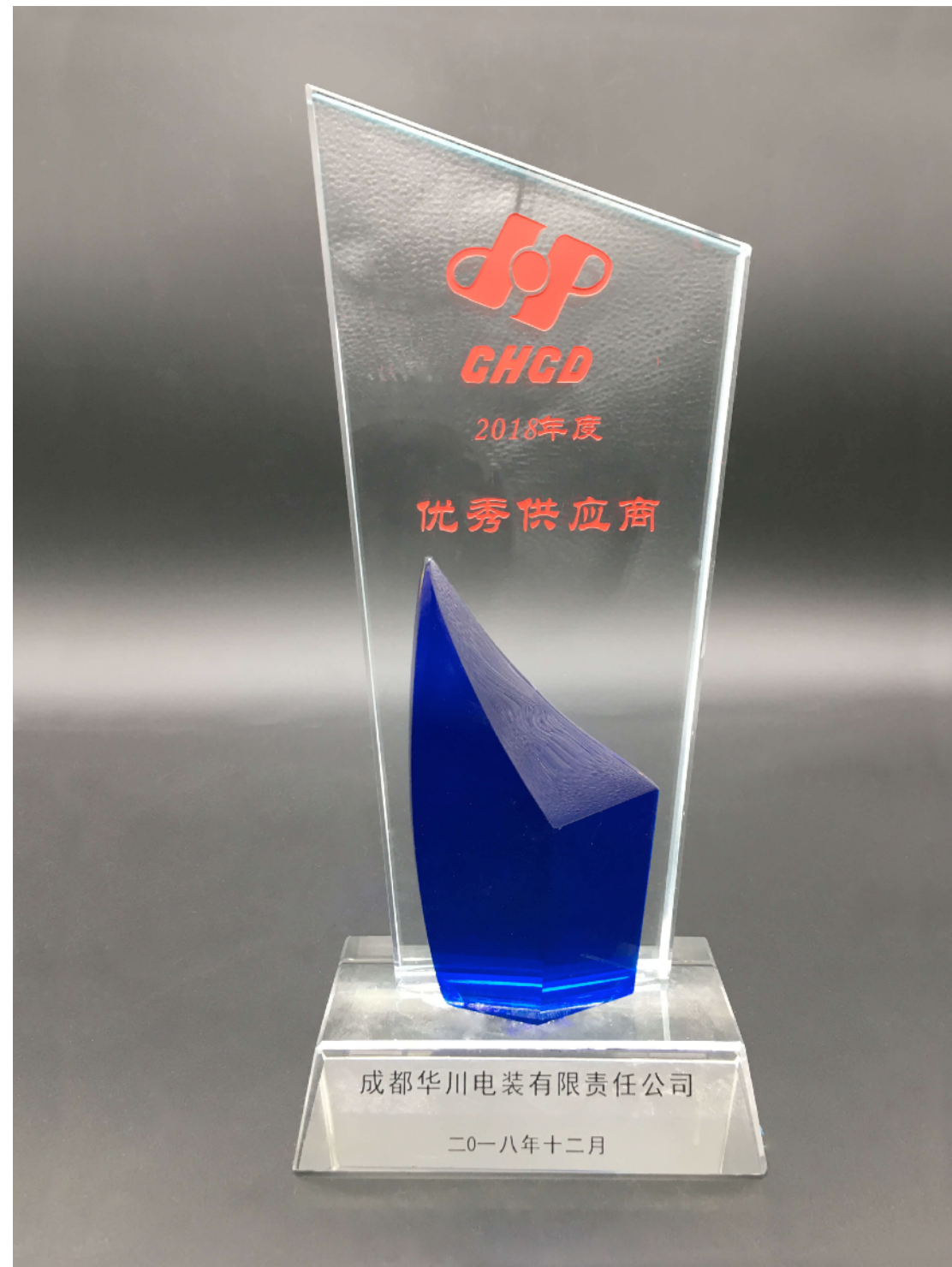

2018 Best Supplier

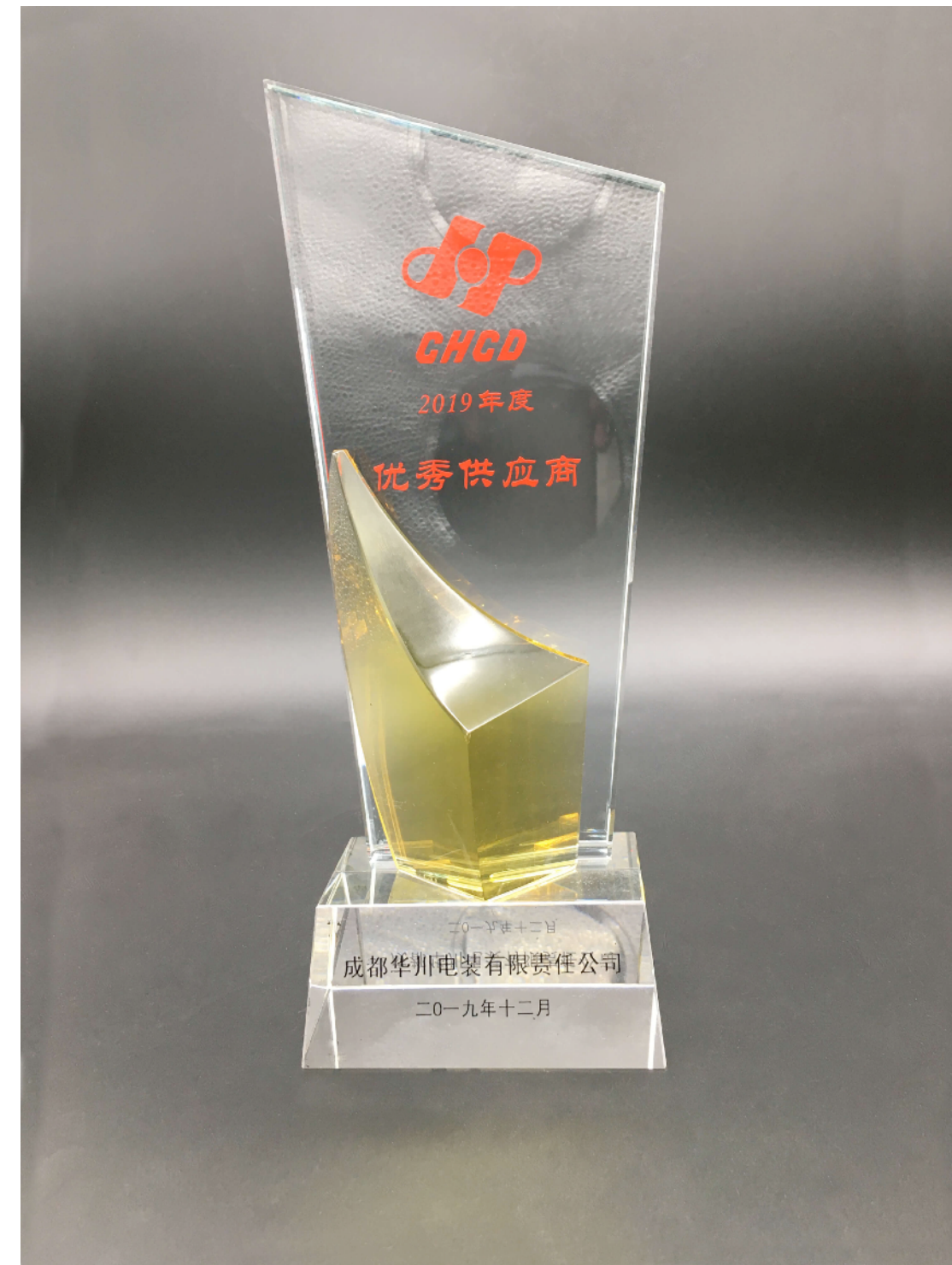

2019 Best Supplier



Member of the Federation of Industry and Commerce
Dujiangyan Chamber of Commerce



Public welfare committee member unit

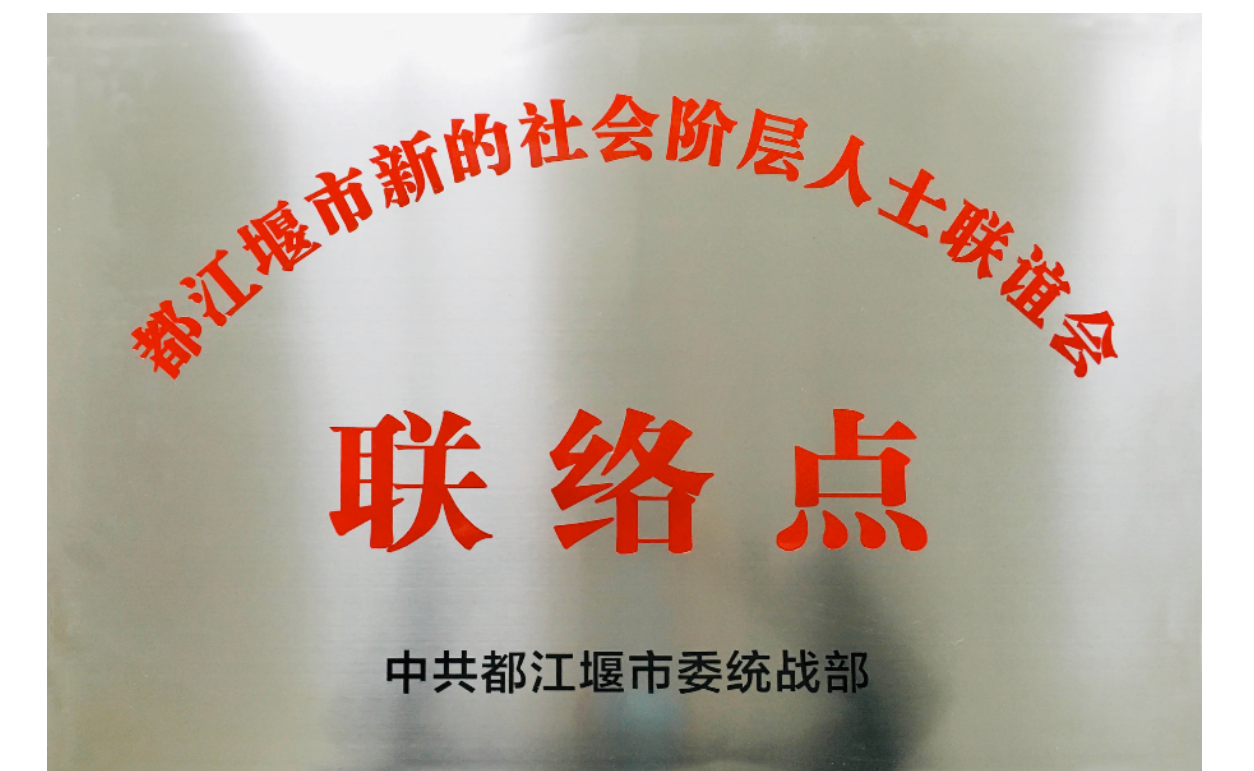

如果我們有幸能為您提供服務，您可将產品與需求通過多種方式直接與我們取得聯系，我們將于第一時間與您聯系溝通了解詳細情況，并為您及時解決問題與困惑，我們期待您的來信。

If we are fortunate to be able to provide services to you, you can directly contact us through a variety of products and requirements. We will contact you as soon as possible to understand the details and solve your problems and confusions in a timely manner. We look forward to Your letter.

座機 Tel +86 (028) 8712 5500

電話 Phone +86 15228822885 / +86 152 0284 5389

郵箱 Mail 172771909@qq.com

地址 Add 中華人民共和國四川省成都市都江堰雙柏村

Shuangbai Village, Dujiangyan, Chengdu City, Sichuan Province, China

謝謝閱讀

THANKS FOR READING!

感謝您抽出寶貴時間了解華川壓鑄
期待您與我們聯系洽談合作

THANK YOU FOR TAKING THE TIME TO UNDERSTAND HUACHUAN DIE CASTING
LOOKING FORWARD TO CONTACTING YOU TO DISCUSS COOPERATION



HUACHUAN
華川壓鑄

都江堰華川壓鑄有限公司

DUJIANGYAN HUACHUAN DIE CASTING & MACHINING CO., LTD

联系方式 Contact +86 028 87125500

地址 中国四川省成都市都江堰双柏村

Add Shuangbo Village, Puyang Town, Dujiangyan, Chengdu City, Sichuan Pro, China